

Interactive comment on “A geophone-based and low-cost data acquisition and analysis system designed to microtremor measurements” by Ozkan Kafadar

Ozkan Kafadar

ozkankafadar@gmail.com

Received and published: 15 July 2020

I would like to thank the Editor and the anonymous reviewer for their constructive comments which helped me improve the quality of my work. To address these comments, I have carefully revised the paper. In the following, I provide a point-by-point response to the comments and detail the actions that I have taken to address those issues. For ease of cross referencing, the performed changes in this revised manuscript are highlighted in red color.

Comment 1: In your reply to my first comment you added several sentences in the first paragraph of the introduction section. All the sentences better describe the different

C1

kind of seismic sensors. Anyway I do not completely agree with the final part of the sentence “On the other hand, geophones are velocimeter, which are often preferred in local seismic applications because of their excellent reliabilities, highly sensitivities and low costs.” I suggest to remove “low costs” because this is not true. Therefore, substitute “because of their excellent reliabilities, highly sensitivities and low costs” with “because of their excellent reliabilities and highly sensitivities”.

Reply 1: Thank you very much for your suggestion. I removed the “low costs” term. Page 1-2, line 23-25: On the other hand, geophones are velocimeter, which are often preferred in local seismic applications because of their excellent reliabilities and highly sensitivities.

Comment 2: Figure 9: substitute “H/V spectrum ratios” with “H/V spectral ratios”.

Reply 2: Thank you very much for your suggestion. I used the “spectral” term instead of the “spectrum”.

Figure 9. The obtained H/V **spectral** ratios of recorded data by a) GeoBox b) MicDAC.

Comment 3: Figure 9: there is a perfect match between H/V spectral ratios obtained from data recorded by GeoBox and MicDAC above 2 Hz. On the other hand, below 2 Hz the H/V functions significantly differ each other. Could you explain why? Is this difference due to the different quality of sensors for frequencies below 2 Hz? Please, justify this possibly with the help of an additional figure if necessary.

Reply 3: Thank you very much for your suggestion. The reason of the difference at frequencies below 2 Hz is that the GeoBox uses an electronic circuit board to obtain a flat band wider than the natural band of the geophone and moves the eigen-frequency to lower value. In this way, it can obtain better sensitiviyy at lower frequencies. I briefly explained the reason of amplitude difference of H/V curves at frequencies below 2 Hz in the last paragraph of Section 3.3

Page 8, line 145: Finally, the MicDAC was compared with a triaxial digital seismograph

C2

called as GeoBox manufactured by SARA Electronic Instruments. The GeoBox is an instrument designed especially for recording ambient seismic noise, and its different versions with sensors of 2 and 4.5 Hz are available in the market. In this study, the SR04HS model with 4.5 Hz sensors of GeoBox was used to make a comparison with MicDAC. The signals recorded simultaneously by MicDAC and GeoBox are shown in Fig. 8a and Fig. 8b. Log-MT software was used to monitor and to record the signals with GeoBox. Two different gain levels, 46 dB and 60 dB, were used in the signals recorded using MicDAC. As a result of this comparison in the time domain, a good correlation between the recorded signals using GeoBox and MicDAC was observed. This similarity was also observed in their frequency spectra (Fig. 8c). In addition to the comparisons in the time and frequency domains, their H/V spectral ratios were also obtained using the Geopsy software (Fig. 9a and 9b). The obtained H/V peak frequencies and amplitudes were given in Table 2. A good correlation was observed between the calculated H/V peak frequencies and amplitudes. **The main reason for the differences in the amplitudes of the H/V curves at frequencies below 2 Hz is related to the electronic design of the GeoBox. Since GeoBox has an electronic architecture that can obtain a flat band wider than the natural band of the geophone embedded in the instrument. Therefore, it obtains better sensitivity at low frequencies.**

Interactive comment on Geosci. Instrum. Method. Data Syst. Discuss.,
<https://doi.org/10.5194/gi-2020-11>, 2020.

C3

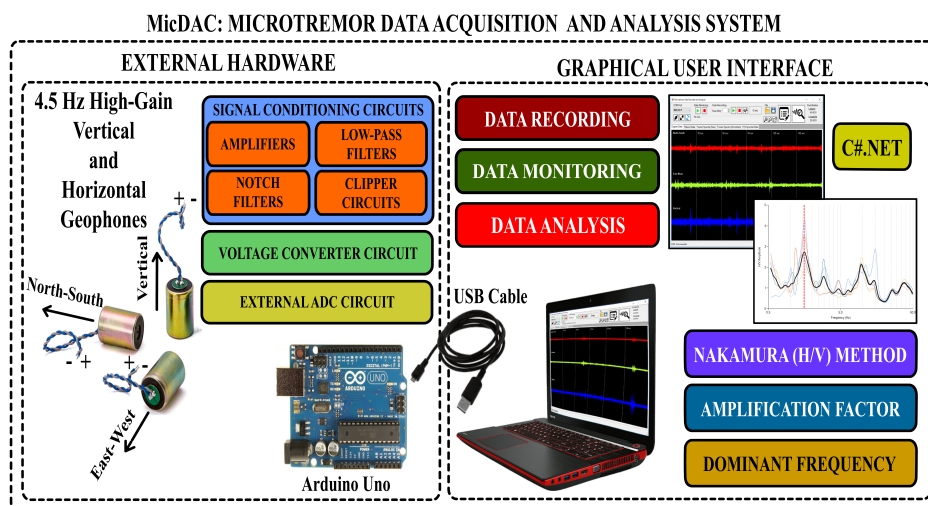

Fig. 1. Graphical abstract of the proposed system for measurement and analysis of three-component microtremor data.

C4

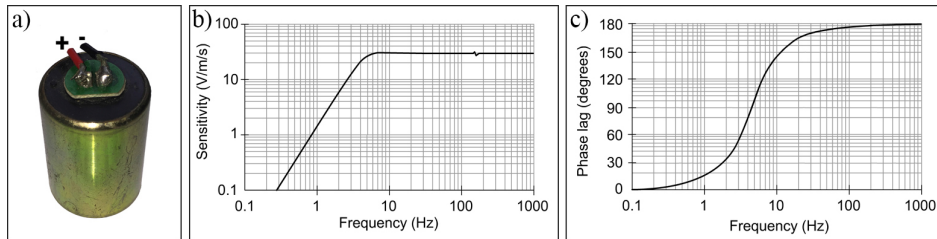

Fig. 2. For the geophones with 4.5 Hz natural frequency a) External view b) Amplitude response c) Phase response.

C5

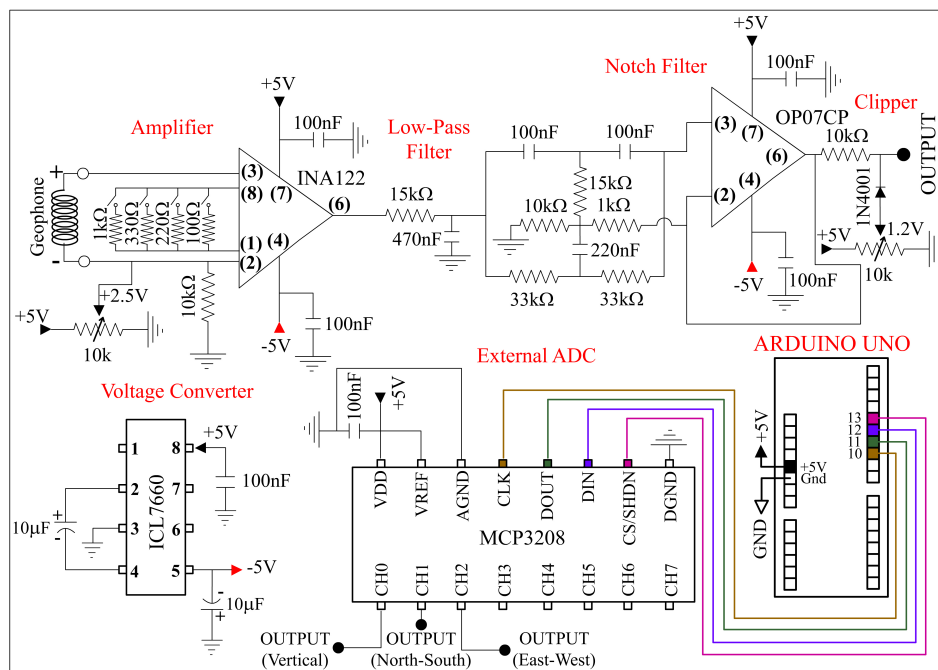

Fig. 3. Schematics of external hardware and pin connections.

C6

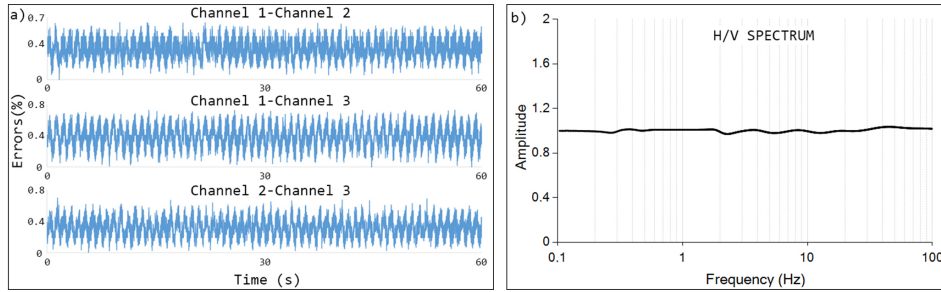

Fig. 4. a) Error percentage of difference signal estimated during the first channel consistency test b) H/V spectral ratio.

C7

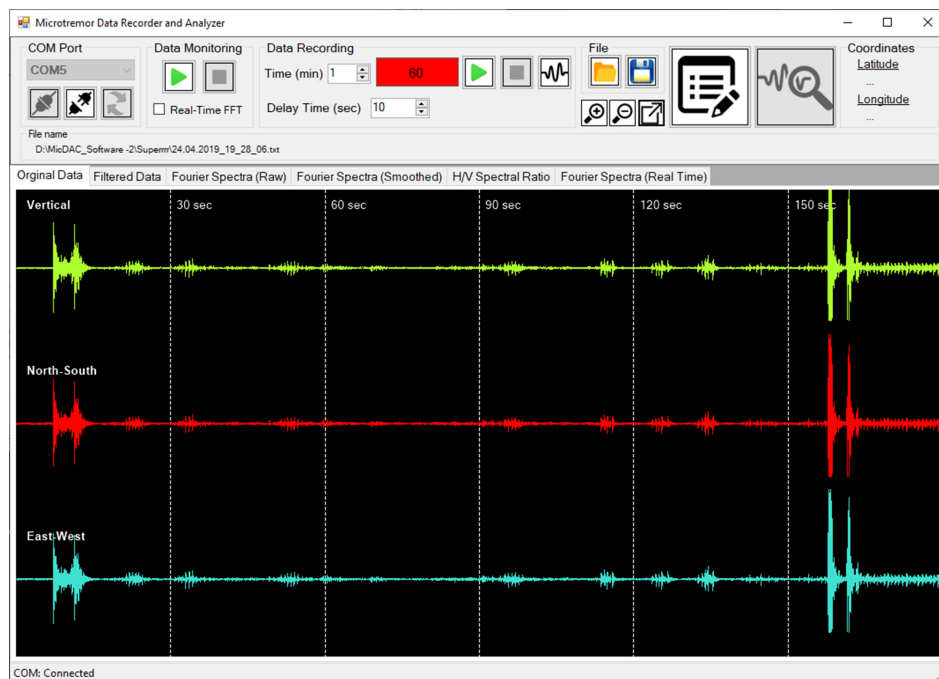

Fig. 5. Screenshot of MicDAC-GUI and detected signals using a 4.5 Hz vertical geophone connected to each channel inputs.

C8

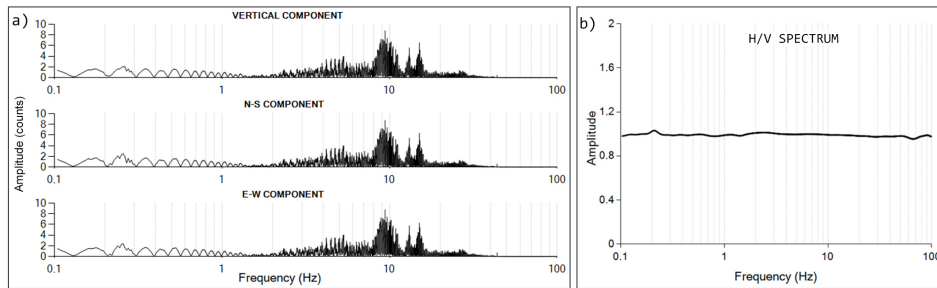

Fig. 6. a) Fourier spectra for the recorded three-component data during the second channel consistency test b) H/V spectral ratio.

C9

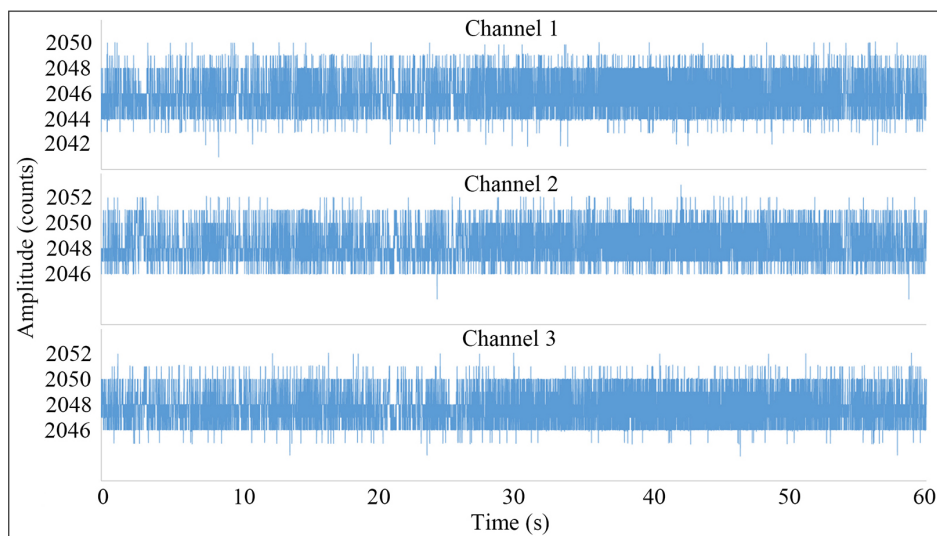

Fig. 7. Internal noise measurements for each channel.

C10

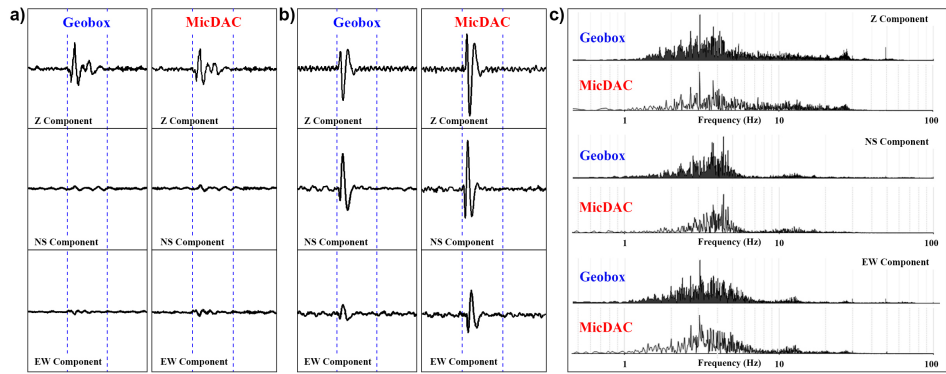

Fig. 8. Three-component seismic data recorded simultaneously using both devices a) MicDAC with 46 dB gain b) MicDAC with 60 dB gain c) Comparison of Fourier spectra of recorded three-component microtremor ...

C11

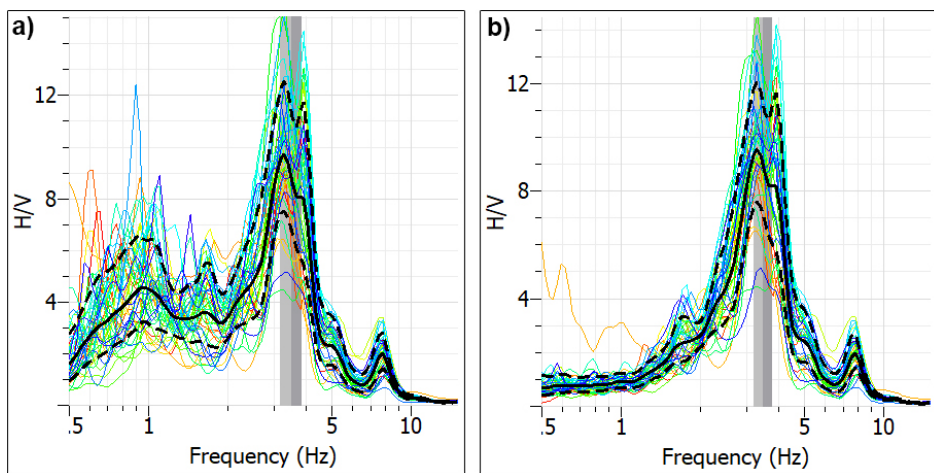

Fig. 9. The obtained H/V spectral ratios of recorded data by a) GeoBox b) MicDAC.

C12

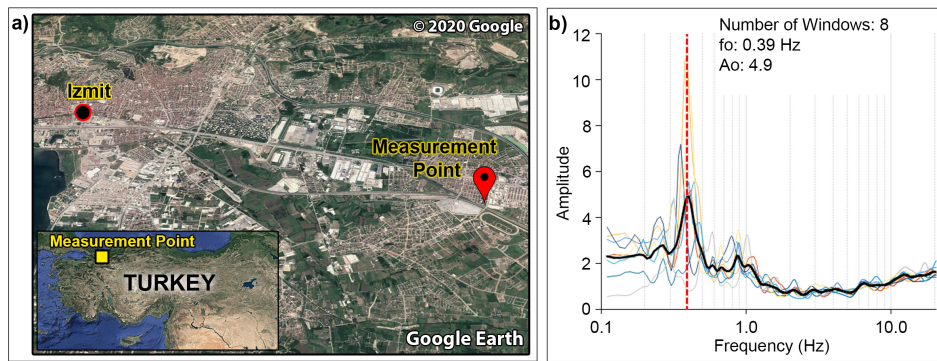

Fig. 10. a) Location of test measurement point on Google Earth[®] view b) H/V spectral ratio.