

# A geophone-based and low-cost data acquisition and analysis system designed to microtremor measurements

Ozkan Kafadar<sup>1</sup>

<sup>1</sup>Department of Computer Programming, Kocaeli University, 41000 Kocaeli, Turkey

**Correspondence:** Ozkan Kafadar (okafadar@kocaeli.edu.tr)

**Abstract.** The commercial data acquisition instruments designed for three-component microtremor measurements are usually very expensive devices. In this paper, a low-cost, computer-aided and geophone-based system designed to record, monitor and analyze the three-component microtremor data, is presented. This proposed system is not a simple data acquisition system. It is also an integrated system developed to interpret the microtremor data using the horizontal-to-vertical spectral ratio (H/V) method without any external software. Therefore, the H/V peak frequency and amplitude can be easily estimated by using this system. The proposed system has several features such as 200 Hz sampling frequency, approximately 72 dB dynamic range, text data format and data analysis tools. This system consists of a graphical user interface developed by using .NET Framework 4.5.2 and an external hardware that includes signal conditioning circuits, voltage converter circuit, external analog-to-digital converter and Arduino Uno board. The proposed system uses the low-cost vertical and horizontal geophones with 4.5 Hz natural frequency to measure three-component microtremor data. The developed software undertakes many tasks such as communication between the external hardware and computer, transferring, monitoring and recording the seismic data to the computer, and interpretation of the recorded data using the Nakamura method. The channel consistency and internal noise measurement tests were performed to demonstrate the accuracy and precision of the proposed system. Besides, the proposed system was compared to a commercial triaxial digital seismograph, and satisfactory results were obtained. The developed system is completely an open-source and open-hardware system, and can be easily used in academic studies conducted by researchers and university students who are interested in seismic ambient noise analysis.

*Copyright statement.* TEXT

## 1 Introduction

The fundamental of the seismic methods is based on the recording of the seismic waves generated by the natural or synthetic sources. There are two type sensors, called velocimeter and accelerometer, with different bandwidths and sensing mechanisms to measure these seismic oscillations. These sensors measure the ground motion as velocity and acceleration, and convert the ground motion into a measurable electrical signal. Accelerometers are electromechanical devices, which measure the acceleration, and are generally used for specific purposes such as vibration and inclination measurements. On the other hand,

geophones are velocimeter, which are often preferred in local seismic applications because of their excellent reliabilities and highly sensitivities. Besides, accelerometers are generally less sensitive than velocimeters and are also used in strong ground motion measurements. Broadband velocimeters have a large passband than geophones, and can measure ground motions with frequencies ranging from 0.001 Hz to 500 Hz. Classical short-period velocimeters are constituted by orthogonally mounted three geophones that have natural frequencies of a few hertz. Data acquisition systems are needed to digitize the analog signals detected by these sensors and to store them in a data storage device. Recently, many studies have been performed to design seismic data acquisition systems. In a study by Khan et al. (2012), a software component was developed to digitize the analog seismic signals using the computer sound card. Llorens et al. (2016) designed a simple data acquisition system for recording the seismic data detected by the vertical geophone to an external SD card. In our previous study, we developed a hardware and software for seismic refraction method (Kafadar and Sertcelik, 2016). In another study, a hardware was designed for recording the seismic noise (Llorens et al., 2018).

In this paper, a low-cost, computer-aided and Arduino-based three-component microtremor measurement and analysis system (MicDAC) is presented. In the literature, there are many data acquisition and analysis systems developed with using the Arduino boards for scientific purposes (Llorens et al., 2016; Fisher and Gould, 2012; Huang et al., 2018; Puente et al., 2017). The MicDAC is controlled through a user-friendly graphical interface (MicDAC-GUI) developed by using the Microsoft .NET Framework 4.5.2 platform and C# language. The MicDAC is not a simple digitizer. Moreover, it is an analysis tool that it can interpret the recorded ambient noise using the Nakamura method (Nakamura, 1989) and it can calculate the two parameters (H/V peak frequency and amplitude), which are too important to design earthquake-resistant structures. This study is completely different from the literature since the proposed system does not require any external software. On the other hand, it can display the calculated Fourier spectra for three-component ambient noise in real-time. This feature provides a pre-information about the frequencies of ambient noise in the survey area before starting the measurement to the user.

## 2 Horizontal-to-Vertical Spectral Ratio (H/V) Method

Except for earthquakes and seismic explosions, the vibrational movements of the earth that occur the natural (winds, oceanic waves and geothermal reactions) or artificial (traffic and industrial machines) causes and whose periods do not exceed a few minutes, are called microseism (Katz, 1976). The microtremor term is used for periods range between 0.05 and 2 seconds. In other words, microtremors are low-amplitude (1-10 microns) and low-frequency (0.5-20 Hz) oscillations. Therefore, broadband seismometers are used to measure these seismic waves.

Microtremors have been classified by some researchers. According to Aki (1957) and Frantti (1963), microtremors are surface waves. Other researchers claim that microtremors are body waves (Kanai, 1962; Douze, 1964). In general, surface sources such as wind, ocean waves and cultural noise generate the surface waves, whereas naturally occurring earth tremors with extremely small amplitude generate the body waves (Weller, 1974).

The horizontal-to-vertical spectral ratio (H/V) technique proposed by Nakamura (1989) is one of the most popular methods developed for the analysis of the microtremor data. This method based on the single-station microtremor data analysis can

easily minimize the source effect by normalizing the horizontal spectral amplitude with the vertical spectral amplitude. The first step to evaluate the microtremor data using the H/V technique is to remove the offsets for each seismic component. This process is performed by subtracting the mean value of signals from each time-domain signal in seismic data. Optionally, low-pass filter can be applied to the recorded signal to remove the high-frequency components. Then the tapering and Fast Fourier Transform operations are applied to each selected time window. The recorded microtremor data are generally split into shorter time windows before starting the analysis process. It is a standard practice to multiply these windows by a taper before performing a Fourier spectrum. The cosine tapers are usually preferred in seismic data analysis. They minimize the discontinuity effect between the ends of the time series (Percival and Walden, 1993).

Raw spectra contain many frequency samples. The Konno-Ohmachi smoothing is widely used to smooth the Fourier spectrum (Konno and Ohmachi, 1998). This process is not mandatory, but strongly recommended. In this study, the quadratic mean is used to calculate the average of two horizontal components. The SESAME (Site effects assessment using ambient excitations) project is the most comprehensive study performed to interpret the H/V curves (SESAME, 2004). In the SESAME report, required conditions to interpret the H/V curves correctly is described in details.

### 3 System Architecture and Design

The MicDAC consists of a developed graphical user interface and an external hardware that includes amplifiers, low-pass and notch filter circuits, clipper circuits, voltage converter circuit, external analog-to-digital converter and Arduino Uno board. The graphical abstract of the MicDAC is shown in Fig. 1. The designed external hardware is connected to the computer via the USB bus. It utilizes the USB port as power supply. Thus, no external battery is required.

#### 3.1 Hardware implementation

The vertical and horizontal geophones manufactured by EGL Company were used to measure three-component microtremor data. They have some characteristic features such as natural frequency of  $4.5 \pm 10\%$  Hz, typical spurious frequency greater than 150 Hz, damping of  $0.6 \pm 5\%$  and open circuit sensitivity of  $28.8 \pm 5\%$  V/m/s. The external view, amplitude response and phase response of these geophones are shown in Fig. 2. There are also geophones with lower frequency on market, but the price of these instruments increases exponentially with decreasing frequencies. Moreover, cost of the high-quality broadband seismometers can reach a mid-level car price. For this reason, in this paper a low-cost hardware-software device is presented to both measure and interpret the three-component microtremor data. Estimated costs of electronic components of the designed external hardware in this study are presented in Table 1. The total cost of the hardware, including the sensors, is approximately 255€.

The output of a geophone consists of two poles and its output voltage is too weak to be recorded without amplification. The voltage difference between these poles can be measured by using various operational amplifiers. The first stage of this signal conditioning circuits consists of differential input and single output INA122 amplifiers Texas Instruments (1997). These amplifiers are instrumentation amplifiers with very important properties such as low-noise ( $60 \text{ nV}/\sqrt{\text{Hz}}$ ), high quality and

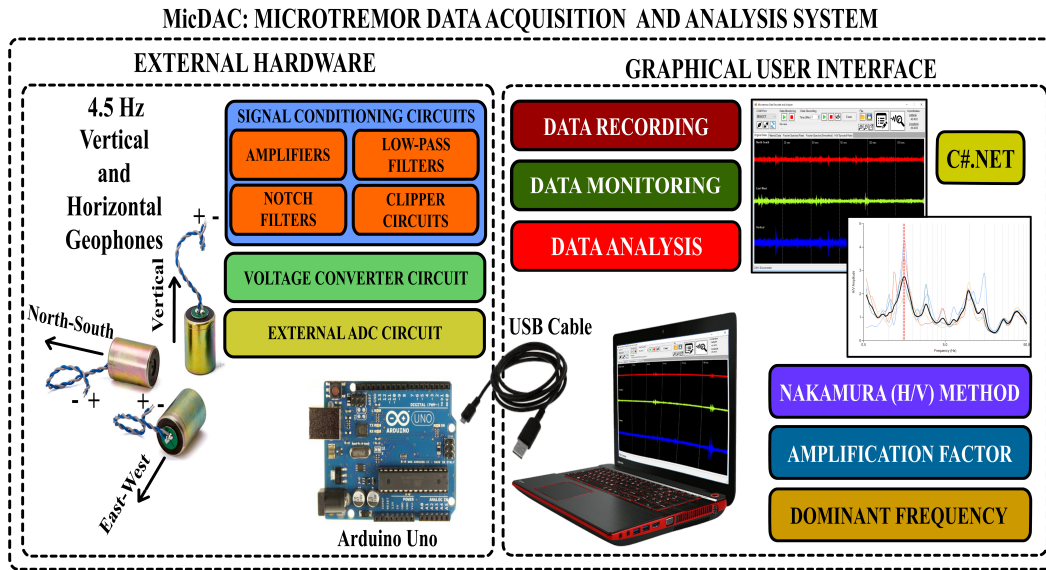

**Figure 1.** Graphical abstract of the proposed system for measurement and analysis of three-component microtremor data.

**Table 1.** List of the electronic components.

Components	Source	Total	Cost (€)
4.5 Hz vertical geophone	Sentez System	x1	65.0
4.5 Hz horizontal geophone	Sentez System	x2	70.0
Arduino UNO + USB cable	Int-el Electronic	x1	21.0
ICL7660 DC-DC converter	Int-el Electronic	x1	1.0
INA122 instrumentation amplifier	Int-el Electronic	x3	5.5
OP07CP operational amplifier	Int-el Electronic	x3	0.3
MCP3208 12-bit ADC	Int-el Electronic	x1	3.0
Resistor, capacitor, diode, potentiometer, DIP switch, connector, jumper cable, crocodile cable	Int-el Electronic		4.0
Breadboard	Int-el Electronic	x3	1.1

90 rail-to-rail output, wide power supply range (single supply: 2.2 V to 36 V, dual supply: -0.9/+1.3 V to -18/+18 V), low offset voltage (250  $\mu$ A max) and low quiescent current (60  $\mu$ A).

In this study, symmetrical power supplies ( $\pm 5$  V) were used to supply these amplifiers. Arduino Uno board can only provide 3.3 V and 5 V positive outputs. For this reason, the ICL7660 integrated circuit was used to obtain the negative power supply (-5 V) from the positive power supply (+5 V). The pin connections of ICL7660 voltage converter and INA122 amplifier are shown in Fig. 3. It can be set four different gain levels (46 dB, 56 dB, 60 dB and 66 dB) for each channel thanks to the DIP  
95 switch and resistors connected to the pins 1 and 8 of INA122 amplifiers.



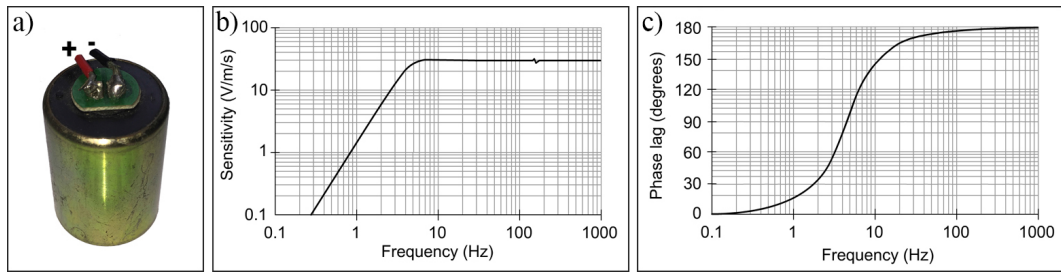

**Figure 2.** For the geophones with 4.5 Hz natural frequency a) External view b) Amplitude response c) Phase response.

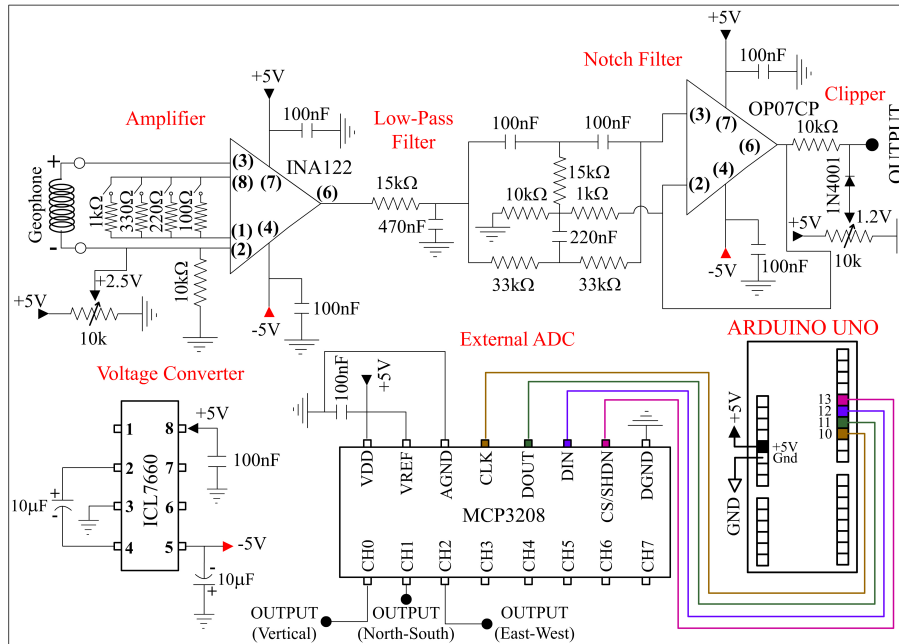

**Figure 3.** Schematics of external hardware and pin connections.

The next step in the external hardware is a passive RC (Resistor-Capacitor) low-pass circuit, which is used to attenuate the high-frequency components in the amplified signal and to avoid the aliasing phenomenon. Cutoff frequency of the low-pass filter was set approximately 22 Hz because the corresponding frequency range in microtremor studies is 0-20 Hz. In the last stage of the signal conditioning circuits, the Twin-T notch filters and clipper circuits were used to remove the 50 Hz interferences and to clip the negative voltage in the output signal, respectively (Fig. 3). Instead of the internal 10-bit analog-to-digital converter on the Arduino board, the MCP3208 12-bit external analog-to-digital converter was preferred to assure higher resolution signals.

### 3.2 Software implementation

The MicDAC sketch (Arduino uses the sketch term for a program) was compiled with Arduino 1.8.8 version and stored as a file, called MicDAC.ino. This sketch digitizes the seismic data with 200 Hz sampling frequency and it transfers the digitized data to the computer via USB bus. The second program (MicDAC-GUI), developed by using .NET Framework 4.5.2 in C# language, is a user-friendly and Windows operating system-based software. The MicDAC-GUI consists of data monitoring mode, data recording mode and analysis tools. It detects the available COM ports automatically. The data monitoring mode is used to display three-component microtremor data in real-time and to test the geophones before starting the recording operation. In addition, this mode is also used to adjust the offset needed to see signals symmetrically through the 10K potentiometer, a component of the external hardware (Fig. 3). The data recording mode is used to record three-component microtremor data during the desired time.

The MicDAC-GUI allows performing records of maximum 180 minutes. When the recording operation ends, the user is alert with an alarm and the temporary data is saved into a file called "datam.txt". The microtremor data are stored in a text file. This data file consists of three columns: V (vertical), NS (north-south) and EW (east-west) components. The recorded signal values vary in the range of between 0 and 4095 because the analog-to-digital converter is 12-bit. Besides, the coordinates of survey area and descriptions are stored in a file with info extension.

The MicDAC-GUI allows many operations such as low-pass filtering, tapering, windowing and smoothing on the recorded data. It can be selected the desired signals thanks to the windowing feature of the MicDAC-GUI. The window length (10.24, 20.48, 40.96, 81.92 and 163.83 seconds) is a user-defined parameter. The time duration of the analysis process increases or decreases depending on the number of enabled time windows and data length. The frequency distribution of each window is displayed separately. This feature gives an idea about the windows that will be used in the analysis. Finally, the horizontal-to-vertical spectral ratios for each selected time window are calculated. The calculated H/V spectral ratios are also numerically displayed using a grid component. After the analysis process ends, the parameters (cutoff frequency of low-pass filter, taper ratio, length of time window, bandwidth of Konno-Ohmachi smoothing function), raw data, low-pass filtered data, Fourier amplitude spectra data, smoothed Fourier amplitude spectra data and H/V spectra data are saved into a text file with "soln" extension.

### 3.3 The reliability and accuracy tests of MicDAC

In this section, three tests were performed in order to demonstrate the accuracy and precision of the MicDAC: (1) channel consistency tests using synthetic and real data; (2) internal noise measurement test and (3) comparison of the characteristics and frequency contents of recorded signals using the proposed system and a commercial microtremor measurement device.

The channel consistency test was performed to evaluate the time-amplitude differences for each channel. Firstly, a 1 Hz sinusoidal signal of 15 mV amplitude generated by the Model FG-8002 function generator manufactured by EZ Digital company was connected to each input channel and these signals were recorded over a period of 60 seconds with a 46 dB gain. After that, the differences of the recorded signals for each channel were calculated. As shown in Fig. 4a, the error percentages (am-

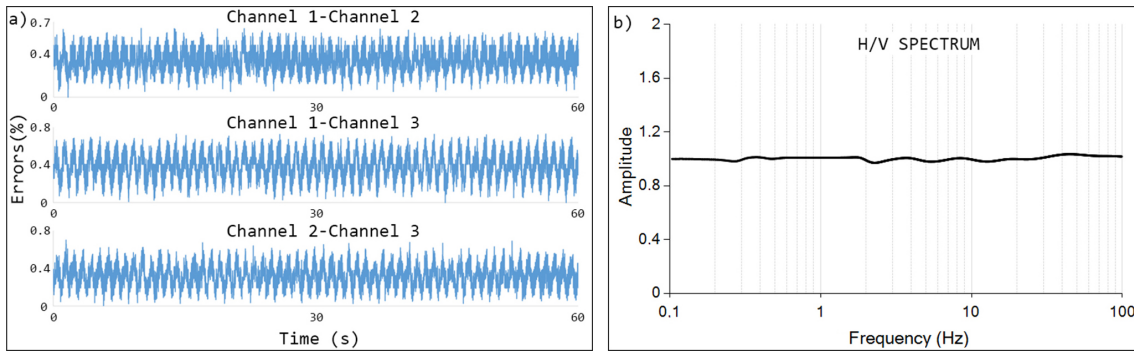

**Figure 4.** a) Error percentage of difference signal estimated during the first channel consistency test b) H/V spectral ratio.

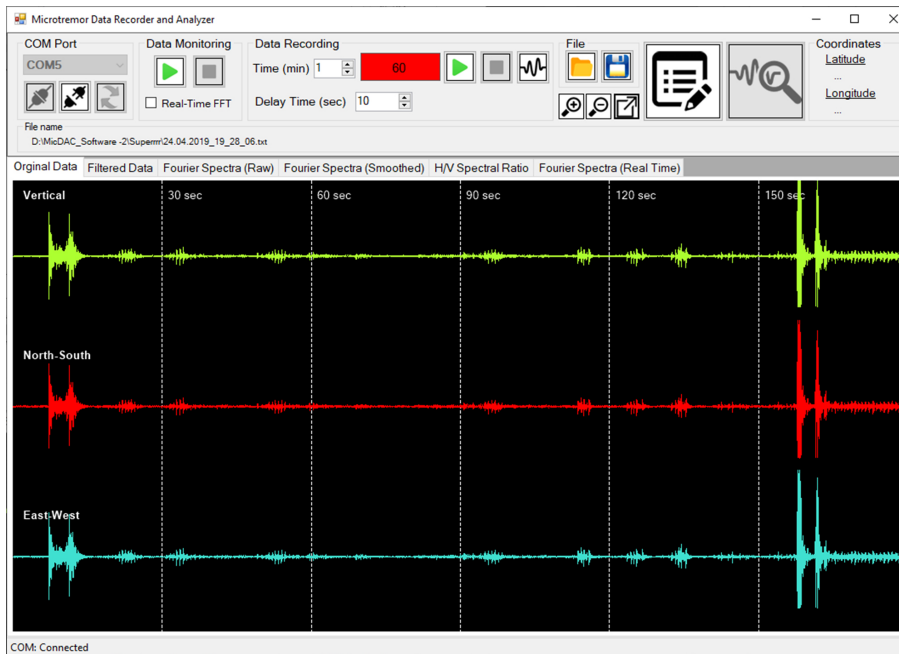

**Figure 5.** Screenshot of MicDAC-GUI and detected signals using a 4.5 Hz vertical geophone connected to each channel inputs.

plitudes of difference signals  $\times 100/4096$ ) of the difference signals (Channel 1-Channel 2, Channel 1-Channel 3 and Channel 2-Channel 3) are lower than 1%. The H/V ratio were calculated using the same sinusoidal signals recorded by three channels and presented in Fig. 4b. The H/V ratio will be equal 1 because the same sinusoidal signals were applied to each channel input.

Secondly, channel consistency test was conducted with using real sensors. For this purpose, same vertical geophone, placed on the table in a building, was connected to the inputs of each channel and the ambient noise is recorded over a period of 180 seconds (Fig. 5). In this test, the calculated Fourier spectra were utilized to demonstrate the frequency contents of three channels. The calculated Fourier spectra and H/V ratio are shown in Fig. 6a and 6b, respectively.

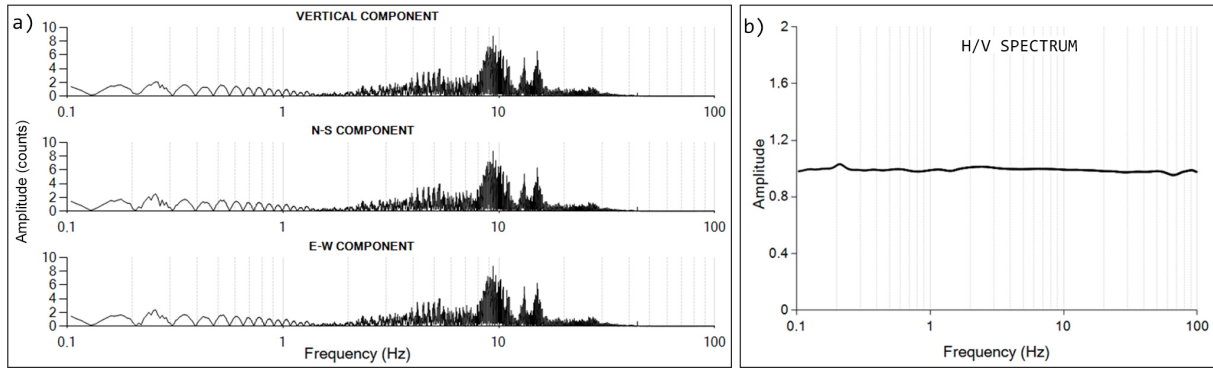

**Figure 6.** a) Fourier spectra for the recorded three-component data during the second channel consistency test b) H/V spectral ratio.

**Table 2.** H/V peak frequencies and amplitudes calculated from the data recorded simultaneously by GeoBox and MicDAC.

	GeoBox	MicDAC
H/V peak frequency (Hz)	3.5034	3.4919
H/V peak amplitude	8.8663	8.9264

In the next test, the internal noise of MicDAC was recorded during a time period of 60 seconds with 200 Hz sampling frequency (Fig. 7). The noise levels of three channels were observed as approximately  $\pm 3$  counts ( $7.3242$  mV,  $9.39 \times 10^{-5}$  m/s).

145 Finally, the MicDAC was compared with a triaxial digital seismograph called as GeoBox manufactured by SARA Electronic Instruments. The GeoBox is an instrument designed especially for recording ambient seismic noise, and its different versions with sensors of 2 and 4.5 Hz are available in the market. In this study, the SR04HS model with 4.5 Hz sensors of GeoBox was used to make a comparison with MicDAC. The signals recorded simultaneously by MicDAC and GeoBox are shown in Fig. 8a and Fig. 8b. Log-MT software was used to monitor and to record the signals with GeoBox. Two different gain levels, 46  
150 dB and 60 dB, were used in the signals recorded using MicDAC. As a result of this comparison in the time domain, a good correlation between the recorded signals using GeoBox and MicDAC was observed. This similarity was also observed in their frequency spectra (Fig. 8c). In addition to the comparisons in the time and frequency domains, their H/V spectral ratios were also obtained using the Geopsy software (Fig. 9a and 9b). The obtained H/V peak frequencies and amplitudes were given in Table 2. A good correlation was observed between the calculated H/V peak frequencies and amplitudes. The main reason for the differences in the amplitudes of the H/V curves at frequencies below 2 Hz is related to the electronic design of the GeoBox. Since GeoBox has an electronic architecture that can obtain a flat band wider than the natural band of the geophone embedded in the instrument. Therefore, it obtains better sensitivity at low frequencies.

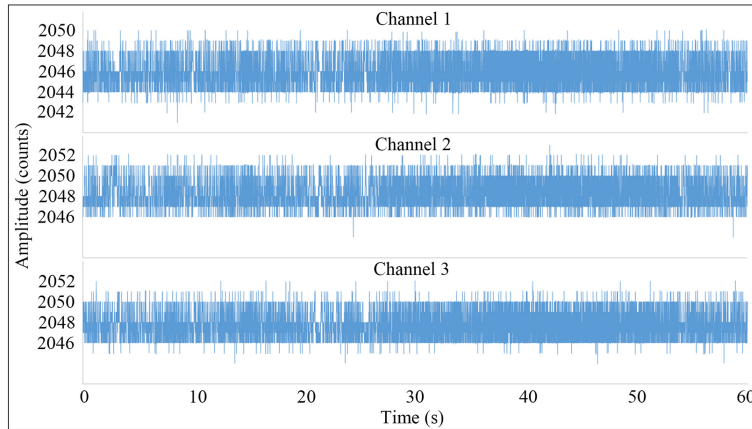

**Figure 7.** Internal noise measurements for each channel.

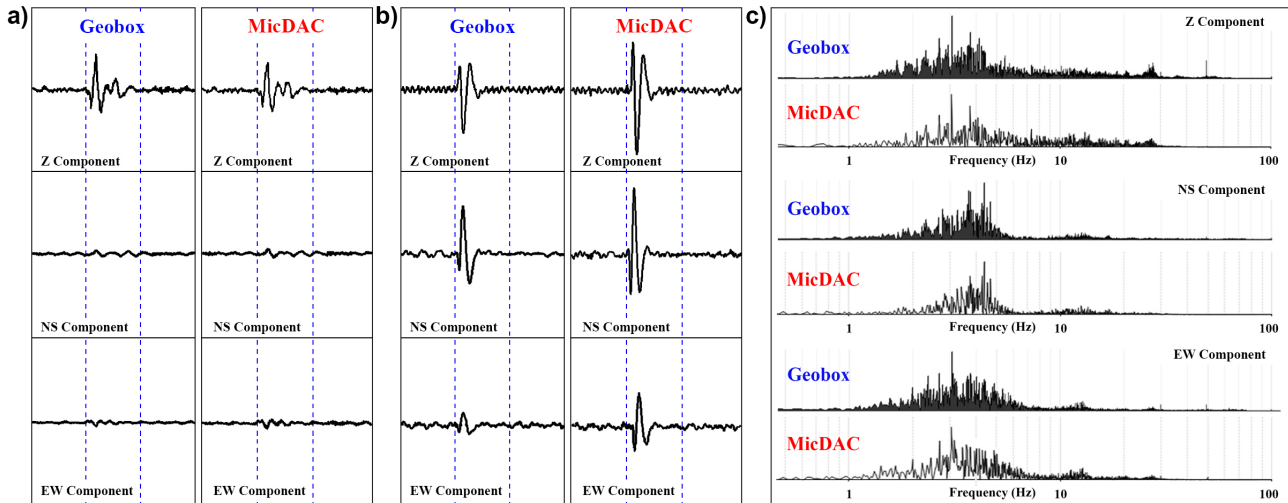
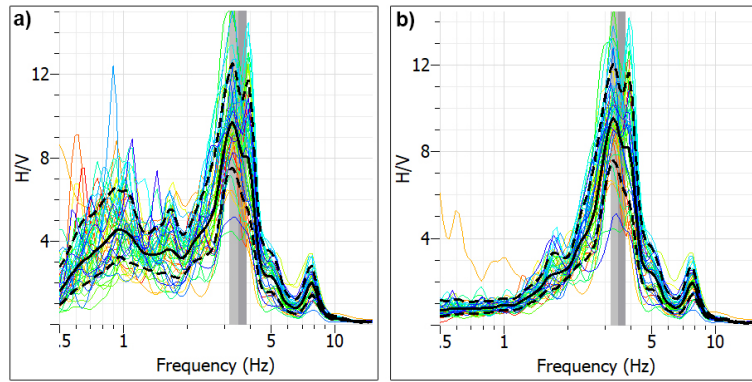

**Figure 8.** Three-component seismic data recorded simultaneously using both devices a) MicDAC with 46 dB gain b) MicDAC with 60 dB gain c) Comparison of Fourier spectra of recorded three-component microtremor data using GeoBox and MicDAC.

#### 4 Experimental Study

In this section, another test measurement was performed to test the performance of MicDAC in field conditions and to compare the obtained results with a previous study. For this purpose, a previously measured area was selected for recording the ambient noise. The measurement point is located in Kartepe district in Marmara region, Turkey (Fig. 10a).

This region is in the middle of Izmit basin and the upper strata of this basin composed of alluvium deposits consisting of silt, sand, gravel and clay. In this region, a large-scale study for site classification and seismic hazard assessment was already conducted by Marmara Research Center of TÜBİTAK and Greater Metropolitan Municipality of Kocaeli (Özalaybey et al.,



**Figure 9.** The obtained H/V spectral ratios of recorded data by a) GeoBox b) MicDAC.

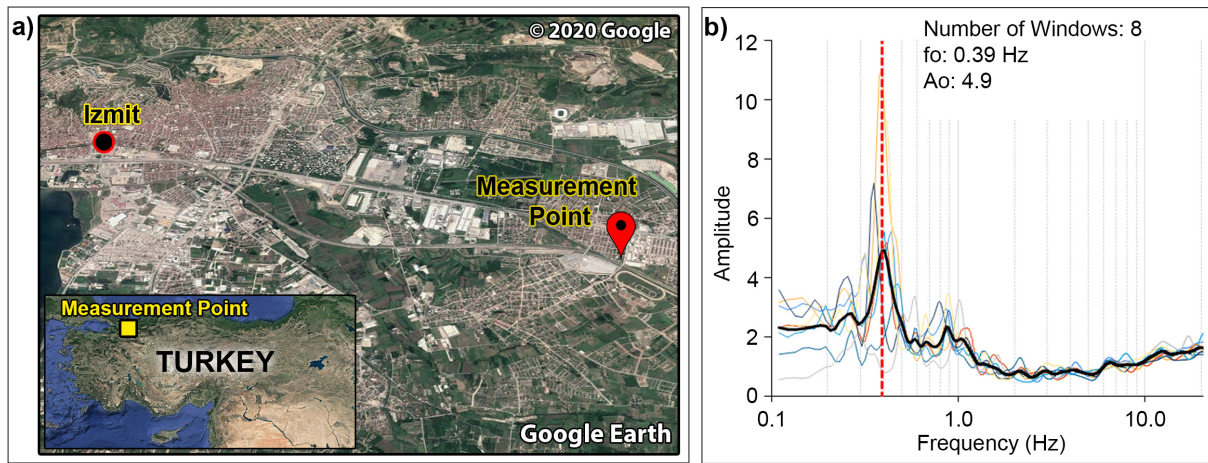

**Figure 10.** a) Location of test measurement point on Google Earth© view b) H/V spectral ratio.

165 2008, 2011). According to their study, the thickness of the sediments of the Izmit basin was calculated as approximately 715  
 170 meters in the area. Especially, in the regions located in the middle of Izmit Basin, it was obtained that the H/V peak frequency  
 varies between 0.2 and 1.0 Hz and the corresponding magnification values are between 5-6 times (Özalaybey et al., 2008).

The ambient noise was recorded during a period of 20 minutes. The relation between the expected minimum frequency  
 and recording duration is explained SESAME report in details (SESAME, 2004). The recorded signal was split into 14 time  
 windows of 81.92 seconds and 8 of them were used for the analysis. 5% cosine tapering and 10 Hz low-pass filtering operations  
 were applied to the selected windows, and Fourier spectra for each window were calculated. The Konno-Ohmachi filter with  
 bandwidth  $b=40$  was used to obtain the smoothed Fourier spectra. Then H/V spectral ratios were calculated for each window.  
 Finally, the H/V peak frequency and amplitude for the measurement point were determined as 0.39 Hz and 4.9, respectively  
 (Fig. 10b). These findings showed that the obtained results were consistent with the literature (Özalaybey et al., 2008).

The aim of this study is to develop a low-cost, computer-aided and Arduino-based three-component microtremor data acquisition and analysis system using the basic electronic components, integrated circuits and Microsoft .NET Framework 4.5.2 application development platform. The designed external hardware can be easily assembled by readers and controlled through a developed graphical user interface using C# language. This software allows monitoring and recording the three-component microtremor data, and analyzing the recorded data using the horizontal-to-vertical spectral ratio (H/V) technique. In this way, the peak frequency and amplitude of H/V curve can be estimated. The channel consistency, internal noise measurement and comparison tests were performed to demonstrate the accuracy and precision performances of the proposed system. In the channel consistency test, it was shown that the error percentage of the difference signals were lower than 1%. Besides, it was shown that the H/V is equal to 1 when a single sensor is connected to each channel input at the same time. In the internal noise measurement test, the noise levels for three channels were observed as approximately  $\pm 3$  counts. In particular, the H/V curves obtained from data recorded simultaneously with MicDAC and GeoBox and their peak frequencies and amplitudes proved the reliability of the proposed system. Finally, an experimental study was performed to test the performance of MicDAC in field conditions. The obtained H/V peak frequency and amplitude from the experimental study were compared to a previous study, and it was shown a good correlation between them. Therefore, it can be concluded that MicDAC is a suitable and inexpensive alternative system for three component microtremor measurements and H/V analysis.

*Code availability.* The MicDAC software folder with the size of 10 MB, contains an Arduino sketch program, executable file folder, MicDAC open-source software files and readme file. The MicDAC software was developed by using the C#.NET language. It is based on Microsoft Windows OS and Framework 4.5.2. The developed graphical user interface, device firmware and other supplementary files can be supplied from the author or downloaded from GitHub, a web-based repository hosting service: <https://github.com/ozkankafadar/MicDAC>.

195 *Author contributions.* All stages of this work were carried out by the author

*Competing interests.* The author declares that there are no conflicts of interest

*Acknowledgements.* I would like to thank the Sentez Earth and Structure Engineering Limited Company for allowing me to use their laboratory and equipment.

## References

- 200 Aki K.: Space and Time Spectra of Stationary Stochastic Waves with Special Reference to Microtremors, *Bulletin of the Earthquake Research Institute*, 35, 415-456, 1957.
- Douze E. J.: Signal and noise in deep wells, *Geophysics*, 29, 721-732, 1964.
- Fisher D. K., Gould P. J.: Open-Source Hardware Is a Low-Cost Alternative for Scientific Instrumentation and Research, *Modern Instrumentation*, 1, 8-20, 2012.
- 205 Frantti G.: The nature of high-frequency earth noise spectra, *Geophysics*, 28, 547-562, 1963.
- Huang H., Lee D. H., Chang K., Li W., Dev A. T.: Development of mobile platform for indoor positioning reference map using geomagnetic field data, *Computers and Electrical Engineering*, 68, 557-569, 2018.
- Kafadar O., Sertcelik I.: A computer-aided data acquisition system for multichannel seismic monitoring and recording. *IEEE Sensors Journal*, 16, 6866-6873, 2016.
- 210 Kanai K.: On the spectrum of strong earthquake motions, *Primeras J. Argentinas Ing. Antisismica*, 24, 1962.
- Katz L. J.: Microtremor analysis of local geological conditions, *Bulletin of the Seismological Society of America*, 66, 45-60, 1976.
- Khan K. A., Akhter G., Ahmad Z.: DigiSeis-A software component for digitizing seismic signals using the PC sound card. *Computers & Geosciences*, 43, 217-220, 2012.
- Konno K., Ohmachi T.: Ground-Motion Characteristics Estimated from Spectral Ratio between Horizontal and Vertical Components of  
215 Microtremor, *Bulletin of the Seismological Society of America*, 88, 228-241, 1998.
- Llorens J. L. S., Merino J. J. G., Caturla J. J. G., Eslava P. J., Cintas S. R., Herranz J. R.: Development and programming of Geophonino: A low cost Arduino-based seismic recorder for vertical geophones, *Computers & Geosciences*, 94, 1-10, 2016.
- Llorens J. L. S., Merino J. J. G., Caturla J. J. G., Eslava P. J., Cintas S. R., Herranz J. R.: A low-cost three-component seismic noise recorder for the application of the H/V method, *Sensors & Actuators*, 269, 342-354, 2018.
- 220 Nakamura Y.: A method for dynamic characteristics estimation of subsurface using microtremor on the ground surface, *Quarterly Report of Rail. Tech. Res. Inst.*, 30, 25-33, 1989.
- Özalaybey S., Zor E., Tapırdamaz M. C. et al.: Kocaeli İli için Zemin Sınıflaması ve Sismik Tehlike Değerlendirme Projesi, TÜBİTAK, 5057105, 2008.
- Özalaybey S., Zor E., Ergintav S., Tapırdamaz M. C.: Investigation of 3-D basin structures in the Izmit Bay area (Turkey) by single-station  
225 microtremor and gravimetric methods, *Geophysical Journal International*, 186, 883-894, 2011.
- Percival D. B., Walden A. T.: *Spectral Analysis for Physical Application*, Cambridge University Press, London, 1993.
- Puente S. T., Ubeda A., Torres F.: e-Health: Biomedical instrumentation with Arduino, *IFAC-PapersOnLine*, 50, 9156-9161, 2017.
- SESAME: Guidelines for the implementation of the H/V spectral ratio technique on ambient vibrations: measurements processing and interpretation, European Commission-Research General Directorate, Project No. EVG1-CT-2000-00026, 2004.
- 230 Texas Instruments: Single Supply, MicroPower Instrumentation Amplifier, INA122 datasheet, 1997.
- Weller C. E.: Seismic Exploration Method, U.S. Patent, 3.812.457, 1974.